

Please, read this manual
before use!

Instruction



Gasoline generator

KS 2900	KS 7000E-3 ATS
KS 3000	KS 7000E 1/3
KS 3000E	KS 10000E 1/3
KS 7000	KS 10000E
KS 7000E	KS 10000E-3
KS 7000E-3	KS 10000E ATS
KS 7000E ATS	KS 10000E-3 ATS

Dual fuel generator

KS 2900G	KS 7000E G
KS 3000G	KS 9000E G
KS 3900E G	KS 10000E G
KS 5000E G	

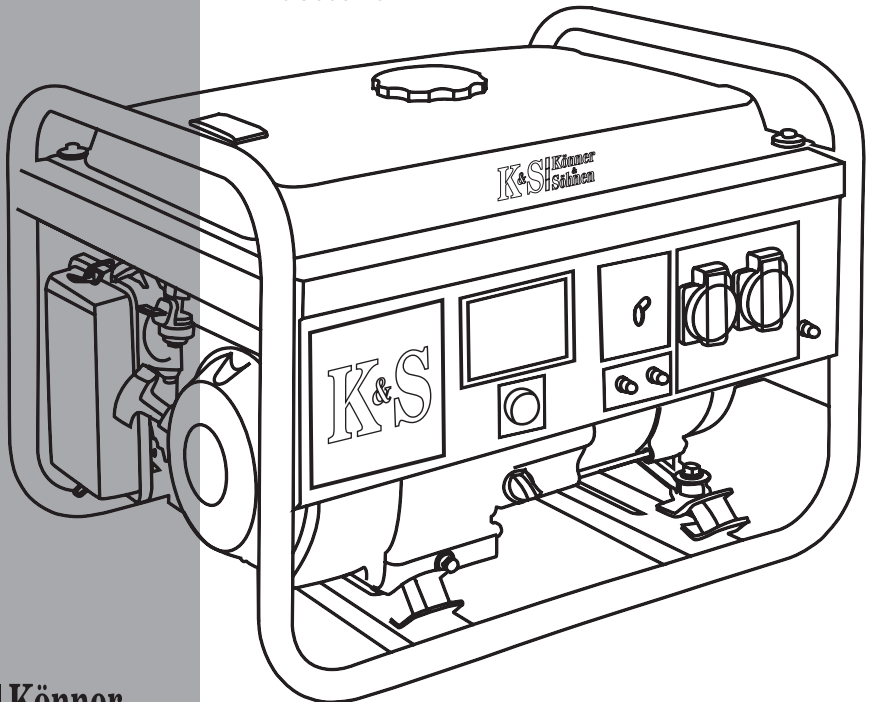

CONTENTS

1. INTRODUCTION	2
2. SAFETY INFORMATION	2
2.1. Working area	2
2.2. Electrical safety	3
2.3. Personal safety	3
2.4. Precautions when working with gasoline generator	4
2.5. Precautions when working with hybrid generator	4
3. SAFETY SYMBOLS DECRYPTION	6
3.1. Symbols description when working with generator	6
3.2. Safety symbols description when working with accumulator	6
4. DESCRIPTION OF GENERATOR INSCRIPTION	7
5. MAIN OVERVIEW	8
6. DUAL FUEL GENERATOR OVERVIEW	9
7. COMPONENTS OF SET	9
8. MODELS DESCRIPTION	10
9. CONTROL PANEL TYPES	17
9.1. Generator panel	17
9.2. Generator panel for models KS 7000E ATS, KS 7000E-3 ATS, KS 10000E ATS, KS 10000E-3 ATS	17
9.3. Generator panel for models KS 7000E 1/3, KS 10000E 1/3	17
10. Digital display of gasoline generators	19
11. COMMISSIONING	19
12. BEFORE STARTING	20
12.1. Check the fuel level	20
12.2. Check the oil level	20
13. CONNECTION OF GENERATOR WITH BUILT-IN ATS	21
13.1. Scheme of connection of a single-phase generator	21
13.2. Connection scheme of the three-phase generator	21
14. ENGINE START	22
14.1. Gasoline generator engine start	22
14.2. Running generator on liquefied gas	23
14.3. Generator launch in ATS mode (for generators with ATS)	24
15. STOPPING THE ENGINE	25
15.1. To stop gasoline generator engine	25
15.2. To stop hybrid generator engine	25
16. TECHNICAL MAINTENANCE WORKS	25
17. MAINTENANCE SCHEDULE	26
18. RECOMMENDED OILS	27
19. AIR FILTER TECHNICAL MAINTENANCE	28
20. SPARK PLUGS TECHNICAL MAINTENANCE	28
21. BATTERY USE	29
22. STORAGE	29
23. GENERATOR TRANSPORTATION	30
24. POSSIBLE FAILURES AND SOLUTIONS	30
25. AVERAGE POWER USAGE	31
26. WARRANTY SERVICE TERMS	32
27. BATTERY AND GENERATOR DISPOSAL	32

1. INTRODUCTION

We are grateful to you for your purchase of **TM Könner & Söhnen** series gasoline powered generator. This manual contains safe working recommendations, operation and adjustment description of these generators and maintenance instructions.

Manufacturer reserves the right to make alterations into the generators, which may not be reflected in this manual. Pictures and photos of the product may vary from its actual appearance. At the end of this manual, You may find contact information which you are free to use in case of any issues occurrence.

All data, specified in this operation manual is the most up to date for the moment of its publishing. The current list of service centers you can find at the website of official importer: www.ks-power.de/en



In order to provide equipment integrity and avoid any possible injuries we strongly recommend You to carefully read this manual before operating the generator.

ABBREVIATIONS MEANING:

KS	Generator model
E	Electro start
G	Dual fuel type (LPG/gasoline)
ATS	Automatic transfer switch

Read carefully these instructions. Pay special attention to information that begins with these characters / words:



Failure to follow the recommendations marked with this sign may lead to serious injury or death of the operator or third parties.



Useful information while operating the machine.

2. SAFETY INFORMATION

2.1. WORKING AREA

- As exhaust gases contain poisonous carbon dioxide (CO₂) and carbon monoxide (CO) gases which are dangerous for life, it is strictly forbidden to install the generator in residential buildings, premises connected to residential buildings by a common ventilation system, other rooms from which exhaust gases may enter living premises.

- Do not use generator in the rain, snow and high humidity conditions, do not touch the generator with wet hands. It's prohibited to leave it in direct sunlight in summer for a long time. It is recommended to store and use the generator under a canopy or in a well ventilated area.

- Please set the generator on a flat hard horizontal surface. To reduce vibration during operation and to avoid damage to the surface, where the generator is installed, it is equipped with dampers.
- Please don't use the generator near flammable gases, liquids or dust. When using the generator exhaust system gets very hot. This may cause fire or explosion of these materials.
- Be sure to follow cleanliness and good lighting in the work area. Clutter and poor lighting may cause an injury.
- Do not let the presence of unauthorized persons, children or animals when working with generator. If necessary, make sure to fencing the working area.
- Please use safety shoes and protective gloves when working with generator.

2.2. ELECTRICAL SAFETY



The device generates electricity. Follow safety precautions to avoid electric shock.

- The generator produces electricity that may lead to an electric shock while neglecting compliance regulations.
- In the high humidity level conditions generator exploit is prohibited. Keep the generator in a dry place only.
- Avoid direct contact with grounded surfaces (pipes, radiators, etc.).
- Do not allow moisture in the generator. The water inside the device increases the risk of an electric shock.
- Be careful when working with power cables. Immediately replace it in case of damage, as damaged wire increases the risk of electric shock.
- All connecting the generator to the network must be made by certified electrician in accordance with all electrical rules and regulations.
- Connect the generator to the protective ground before operation.
- Do not connect or disconnect a generator to electricity consumers, which are placed in water on a wet or damp soil.
- Do not touch parts of the generator under voltage.
- Connect the generator to those customers only which meet the electrical characteristics and the rated power of the generator.
- Store all electrical equipment dry and clean. Wires with damaged or spoiled insulation should be replaced. You should also replace worn, damaged or rusty contacts.



Using device for other purposes deprives the right for free warranty.

2.3. PERSONAL SAFETY

- Be careful. Do not operate the generator, if you are tired, under the influence of drugs or alcohol. Inattention may cause a serious injury.
- Do not wear loose clothing or jewelry when working. Long hair, jewelry or loose clothing may get into the moving parts of the generator and cause an injury.



ATTENTION - DANGER!



Non compliance to these requirements may result in generator combustion or explosion, as well as in electric wiring ignition inside the structure.

- Avoid inadvertent start. Make sure to set the switch to Off when you turn off the generator.
- Make sure no outsider objects are on the generator when it is turned on. Do not overload the generator, use it only for the purpose. Proper use of the generator will do the job for which it is designed better and safer.
- Using device for other purposes deprives the right for free warranty. It is not allowed to sit or stand on the generator.
- Always keep a stable position and balance when starting the generator.
- Use safety equipment. Always wear goggles, a mask, non-slip sole shoes, protective helmet, headphones.
- To avoid inhaling exhaust gas, the generator does not have to work in conditions of poor ventilation. Exhaust gas contains poisonous carbon monoxide. Use and maintenance of the generator.
- Before you start checks before operating, make sure that the generator is on a flat level surface and the engine switch is set to Off.
- Keep the generator dry, well ventilated place if you are not using it.
- Check the connection of moving parts, no damaged parts that affect the operation of the generator. If the generator is damaged, remove them before using.
- For repair and maintenance use only recommended oil fuel. Using other lubricants, spare parts and consumables deprives you of warranty apparatus.
- Labels and stickers on the generator and engine leave because they contain important information.
- Servicing the generator should be carried out only by qualified personnel.
- When servicing the generator follow all instructions of this manual.

2.4. PRECAUTIONS WHEN WORKING WITH GASOLINE GENERATOR

- Do not start the generator operation upon presence of electric load. Disconnect the load before you stop the engine.
- Generator installation is to be performed at minimum 1 meter safety distance from flammable objects.
- Do not refuel the running generator.
- It is forbidden to smoke during generator refuelling operations.
- It is forbidden to run the generator during rainfall and in high-moisture level conditions.
- The generator is to be mounted on flat level surface to avoid petroleum leakage.
- Only unleaded gasoline is recommended for the generator. After filling the tank, all excessive fuel spillage are to be removed from the surface. It is forbidden to use kerosene or other fuel types.
- Observe the fuel tank refilling. Do not allow overfilling.
- All explosive and flammable materials or substances are to be kept away from the generator, for its engine produces heat during operation.

- It is forbidden to touch the exhaust system during the generator start and in process of its running.
- It is forbidden to run the generator in cases when its exposure to rain, snow and possibility of soakage exist. Do not touch the generator with moist hands
- Before running the generator, it is necessary to define the place and means of its emergency stop.



Fuel contaminates the land and groundwater. Do not allow the leaking gasoline from the tank!

2.5. PRECAUTIONS WHEN WORKING WITH HYBRID GENERATOR

- You are allowed to connect all the power consuming supplies only after generator got warmed up. If you start generator with appliances being connected the engine may work unstable due to the fuel remains in the carburetor.
- Disconnect the load before you stop the engine.
- Before usage make sure, that all the hoses are connected properly.
- In case of gas leakage, stop the gas flow from the source to generator and switch off all the electric appliances connected as soon as possible.
- For stopping gas powered engine: disconnect all the connected devices first, then close the gas valve, then turn off the engine. After that set the starter switch to OFF position and turn off the gas supply valve.



Do not allow sparks near gas powered generator during its work

3. SAFETY SYMBOLS DECRYPTION

3.1. SYMBOLS DESCRIPTION WHEN WORKING WITH GENERATOR

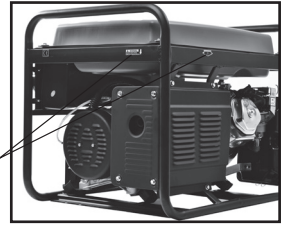

pic 1

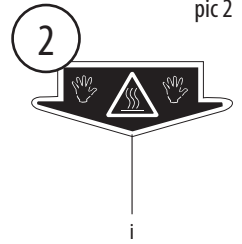
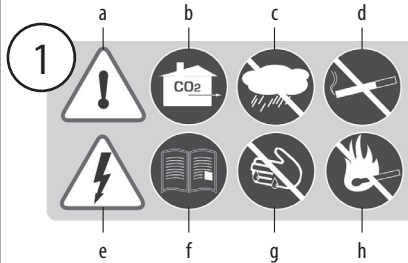

pic 2

- a. Be careful when using the device! Follow safety rules listed in manual.
- b. Use the generator only in areas that are well ventilated, or on open areas. The exhaust gases contain CO₂, which are dangerous to life.
- c. Do not use or store the device in high humidity.
- d. Do not smoke when using the generator!
- e. The device generates electricity. Follow safety precautions to avoid electric shock.
- f. Carefully read the manual before using the device.
- g. Do not touch the generator with wet or dirty hands.
- h. Follow fire safety rules, do not use open flames near the generator.
- i. Please don't touch! The muffler heats up when running the generator.

3.2. SAFETY SYMBOLS DESCRIPTION WHEN WORKING WITH ACCUMULATOR

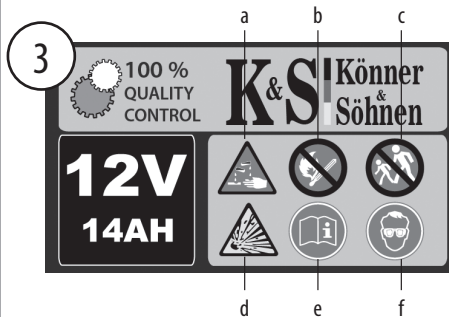

pic 3

- a. Use protective rubber gloves while working with battery. Battery contains acid electrolyte, which is dangerous. If contact with skin or face occurred, rinse it off immediately with plenty of water and consult a doctor.
- b. Do not use open flames near the generator.
- c. Do not allow children to be close to area with generator.
- d. Attention! During the process of battery charging, hydrogen is released, which is explosive! Follow the manual recommendations!
- e. Carefully read the manual before using the device.
- f. Use protective glasses when working with generator.

4. DESCRIPTION OF GENERATOR INSCRIPTION

EXCEPT SAFETY SYMBOLS GENERATOR CONTAINS FOLLOWING INSCRIPTION:

K&S Könner & Söhnen	Gasoline generator set Generator benzynowy	Model: KS 3000
MAXIMUM POWER MOC MASYWALNA	3.0 kW	POWER FACTOR WSPÓŁCZYNNIK MOCY
RATED POWER MOC NOMINALNA	2.8 kW	PROTECTED CLASS STYPIEN OCHRONY
VOLTS NAPIĘCIE	230V	PERFORMANCE CLASS KLASA WYKONAWCZOŚCI
FREQUENCY CURRENT CZĘSTOTLIWOŚĆ	50Hz	AMBIENCE TEMPERATURA
AC RATED CURRENT PRĄD NOMINALNY AC	11.3A	ALTITUDE WYSOKOŚĆ
DC RATED OUTPUT MOC DC	12V	WEIGHT CIĘŻAR
DC RATED CURRENT PRĄD NOMINALNY DC	6.3A	YEAR OF ISSUE ROK WYDANIA
S/N	SERIAL NUMBER IS MARKED ON THE ENGINE OF GENERATOR NUMER IDENTYFIKACYJNY WYKONAWCY NA SILNIKU GENERATORA	

Specification table. For different models this table is different. All characteristics are given in the «Specifications».

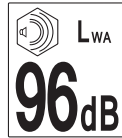

Indicates the noise level. For different models this indicator is different. All characteristics are given in the «Specifications».

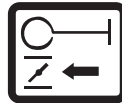

Note which direction you should open air dampers.

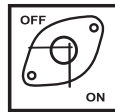

Indicates the position of the fuel tap. Position «ON» - opened, position «OFF» - closed.



Fuel level indicator. The icon on the left indicates that the tank is full, the icon on the right - that the tank is empty.



Carter volume (different for different models)

Oil use recommendations

Recommended maintenance schedule		Every start	First month or 20 hours	Each month or after 20 working hours	Each 3 month or after 50 working hours	Each 6 month or after 100 working hours	Each year or after 300 working hrs
Motor oil	Check the level	X					
	Replace		X		X		
Air filter	Check/Clean out	X	X	X			
	Replace						X
Spark plug	Check/Clean out					X	
	Replace						X
Fuel tank	Check the level	X					
	Clean out						X
Fuel line	Check (replace if needed)					X	

* Clean out more often in a dusty conditions

** Maintenance should be done only by authorized specialist

Maintenance information translated into the language of the country where the generator is sold you may find in «Maintenance».



Information on the required level of oil in the crankcase



Grounding

5. MAIN OVERVIEW

pic 4

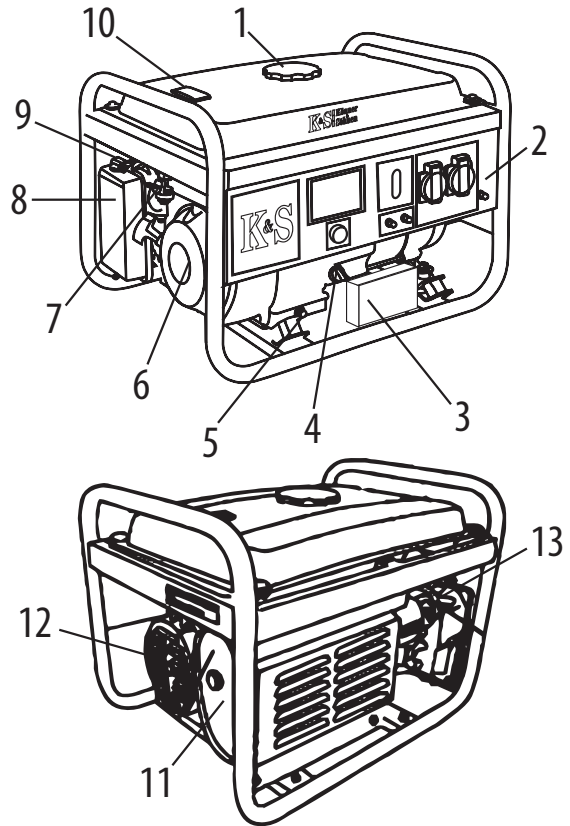

- | | |
|-------------------------------------------------------|--------------------------|
| 1. Fuel tank cap | 7. Fuel valve |
| 2. Control panel | 8. Air filter |
| 3. 12 V power battery
(electric start models only) | 9. Air flap switch |
| 4. Oil-depth gage | 10. Fuel level indicator |
| 5. Oil drain cap | 11. Silencer |
| 6. Manual starter | 12. Alternator |
| | 13. Sparking plug |



IMPORTANT!



Manufacturer reserves the right to make changes and/or improvements in design, components set and technical attributes without notice and without incurring obligation. The pictures in this manual are schematical and may not match the parameters of original product

6. DUAL FUEL GENERATOR OVERVIEW

Except the nodes, described in gasoline generator main overview (pic 5) dual fuel generators are additionally equipped with LPG supply hose. That allows the generator to work either on gasoline or on LPG.

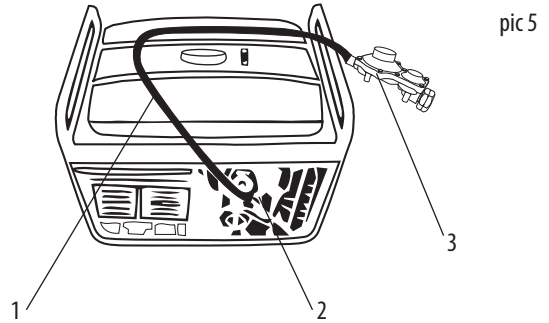

Dual fuel generators additionally equipped with reductor for stable LPG supply.

1. Gas cylinder connection hose (1.5 m).
2. Built-in reducer.
3. Extra reducer on the hose that is mounted on the cylinder.



BE ADVISED! It is strongly forbidden to use gasoline and LPG simultaneously! While using a gasoline source, the LPG supply should be stopped. The same situation is with liquid gas powering.

7. COMPONENTS OF SET

1. Generator
2. Packaging
3. Operating Instructions
4. Key candle
5. Keys to run the generator
(for electrostart models)

8. MODELS DESCRIPTION

Model	KS 2900	KS 2900G
Voltage, V	230	230
Max Power, kW	2,9	2,9
Nominal Power, kW	2,5	2,5
Frequency, Hz	50	50
Current max, A	12,5	12,5
Outlets	2*16A	2*16A
Fuel Tank Volume, l	15	15
50% power working time	15	15
LED display	voltage, frequency, working hours	voltage, frequency, working hours
Noise level L _{PA} (7m)/L _{WA} , dB	68/93	68/93
Power output V/A	12/8,3	12/8,3
Engine model	KS 200	KS 200
Engine type	gasoline 4 stroke cycle engine	LPG/gasoline 4 stroke cycle engine
Engine power, hp	6,5	6,5
Crank case volume, cm ³	0,6	0,6
Engine cylinder volume cm ³	196	196
Power output controller	AVR	AVR
Engine start	manual	manual
Power factor, cosφ	1	1
Dimensions (L*W*H), mm	610x455x485	610x455x485
Weight, kg	41,5	43
Protection class	IP23M	IP23M
Altitude (MAX), m	1000	1000
Relative humidity	<95%	<95%
*Acceptable deviation of a current is 5%		

To ensure the reliability of the generator and increase its lifespan, the peak capacities may be slightly limited by circuit breakers.

The optimum operating conditions are ambient temperature of 17 – 25 °C, barometric pressure of 0.1 MPa (760 mm Hg), and relative humidity of 50 – 60%. Under such ambient conditions, the generator can guarantee maximum performance in terms of the stated specifications. In case of deviations from the above ambient values, the performance of the generator can be different.

Please note that in order to preserve the lifespan of the generator, continuous loads should not exceed 80% of the rated power.

MODELS DESCRIPTION

Model	KS 3000	KS 3000 E	KS 3000 G
Voltage, V	230	230	230
Max Power, kW	3,0	3,0	3,0
Nominal Power, kW	2,6	2,6	2,6
Frequency, Hz	50	50	50
Current max, A	13,04	13,04	13,04
Outlets	2*16 A	2*16 A	2*16 A
Fuel Tank Volume, l	15	15	15
50% power working time	15	15	15
LED display	voltage, frequency, working hour		
Noise level L _{PA} (7m)/L _{WA} , dB	68/93	68/93	68/93
Power output V/A	12/8,3	12/8,3	12/8,3
Engine model	KS 210	KS 210	KS 210
Engine type	gasoline 4 stroke cycle engine	gasoline 4 stroke cycle engine	LPG/gasoline 4 stroke cycle engine
Engine power, hp	7,0	7,0	7,0
Crank case volume, cm ³	0,6	0,6	0,6
Engine cylinder volume cm ³	208	208	208
Power output controller	AVR	AVR	AVR
Engine start	manual	manual/electro	manual
Power factor, cosφ	1	1	1
Dimensions (L*W*H), mm	610x455x485	610x455x485	610x455x485
Weight, kg	41,53	46,19	45,4
Protection class	IP23M	IP23M	IP23M
Altitude (MAX), m	1000	1000	1000
Relative humidity	<95%	<95%	<95%
*Acceptable deviation of a current is 5%			

To ensure the reliability of the generator – and increase its lifespan, the peak capacities may be slightly limited by circuit breakers.

The optimum operating conditions are ambient temperature of 17 – 25 °C, barometric pressure of 0.1 MPa (760 mm Hg), and relative humidity of 50 – 60%. Under such ambient conditions, the generator can guarantee maximum performance in terms of the stated specifications. In case of deviations from the above ambient values, the performance of the generator can be different.

Please note that in order to preserve the lifespan of the generator, continuous loads should not exceed 80% of the rated power.

MODELS DESCRIPTION

Model	KS 3900E G	KS 5000E G	KS 7000
Voltage, V	230	230	230
Max Power, kW	3,2	4,5	5,5
Nominal Power, kW	2,7	4,0	5,0
Frequency, Hz	50	50	50
Current max, A	14	19,5	23,91
Outlets	2*16A	2*16A	1*16 A 1*32 A
Fuel Tank Volume, l	15	25	25
50% power working time	15	17	17
LED display	voltage, frequency, working hourse		
Noise level L _{PA} (7m)/L _{WA} , dB	68/93	70/95	70/95
Power output V/A	12/8,3	12/8,3	12/8,3
Engine model	KS 260	KS 390	KS 390
Engine type	LPG/gasoline 4 stroke cycle engine	LPG/gasoline 4 stroke cycle engine	gasoline 4 stroke cycle engine
Engine power, hp	7,5	13,0	13,0
Crank case volume, cm ³	0,6	1,1	1,1
Engine cylinder volume cm ³	223	389	389
Power output controller	AVR	AVR	AVR
Engine start	manual/electro	manual/electro	manual
Power factor, cosφ	1	1	1
Dimensions (L*W*H), mm	610x455x485	700x545x590	700x545x590
Weight, kg	48,5	77	69,2
Protection class	IP23M	IP23M	IP23M
Altitude (MAX), m	1000	1000	1000
Relative humidity	<95%	<95%	<95%
*Acceptable deviation of a current is 5%			

To ensure the reliability of the generator and increase its lifespan, the peak capacities may be slightly limited by circuit breakers.

The optimum operating conditions are ambient temperature of 17 – 25 °C, barometric pressure of 0.1 MPa (760 mm Hg), and relative humidity of 50 – 60%. Under such ambient conditions, the generator can guarantee maximum performance in terms of the stated specifications. In case of deviations from the above ambient values, the performance of the generator can be different.

Please note that in order to preserve the lifespan of the generator, continuous loads should not exceed 80% of the rated power.

MODELS DESCRIPTION

Model	KS 7000E	KS 7000E G	KS 7000E-3
Voltage, V	230	230	400
Max Power, kW	5,5	5,5	5,5
Nominal Power, kW	5,0	5,0	5,0
Frequency, Hz	50	50	50
Current max, A	23,91	23,91	9,93
Outlets	1*16 A 1*32 A	1*16 A 1*32 A	1*16 A 1*16 A (3p)
Fuel Tank Volume, l	25	25	25
50% power working time	17	17	17
LED display	voltage, frequency, working hours		
Noise level L _{PA} (7m)/L _{WA} , dB	70/95	70/95	70/95
Power output V/A	12/8,3	12/8,3	12/8,3
Engine model	KS 390	KS 390	KS 390
Engine type	gasoline 4 stroke cycle engine	LPG/gasoline 4 stroke cycle engine	gasoline 4 stroke cycle engine
Engine power, hp	13,0	13,0	13,0
Crank case volume, l	1,1	1,1	1,1
Engine cylinder volume cm ³	389	389	389
Power output controller	AVR	AVR	AVR
Engine start	manual/electro	manual/electro	manual/electro
Power factor, cosφ	1	1	0,8
Dimensions (L*W*H), mm	700x545x590	700x545x590	700x545x590
Weight, kg	76,2	77,2	80,8
Protection class	IP23M	IP23M	IP23M
Altitude (MAX), m	1000	1000	1000
Relative humidity	<95%	<95%	<95%
*Acceptable deviation of a current is 5%			

To ensure the reliability of the generator and increase its lifespan, the peak capacities may be slightly limited by circuit breakers.

The optimum operating conditions are ambient temperature of 17 – 25 °C, barometric pressure of 0.1 MPa (760 mm Hg), and relative humidity of 50 – 60%. Under such ambient conditions, the generator can guarantee maximum performance in terms of the stated specifications. In case of deviations from the above ambient values, the performance of the generator can be different.

Please note that in order to preserve the lifespan of the generator, continuous loads should not exceed 80% of the rated power.

MODELS DESCRIPTION

Model	KS 7000E ATS	KS 7000E-3 ATS	KS 9000E G
Voltage, V	230	400	230
Max Power, kW	5,5	5,5	6,5
Nominal Power, kW	5,0	5,0	6,0
Frequency, Hz	50	50	50
Current max, A	23,91	9,93	28,3
Outlets	1*16 A 1*32 A	1*16 A 1*16 A (3p)	1*16A, 1*32A
Fuel Tank Volume, l	25	25	25
50% power working time	17	17	15
LED display	voltage, frequency, working hours		
Noise level L _{PA} (7m)/L _{WA} , dB	70/95	70/95	71/96
Power output V/A	12/8,3	12/8,3	12/8,3
Engine model	KS 390	KS 390	KS 420
Engine type	gasoline 4 stroke cycle engine	gasoline 4 stroke cycle engine	LPG/gasoline 4 stroke cycle engine
Engine power, hp	13,0	13,0	16,0
Crank case volume, l	1,1	1,1	1,1
Engine cylinder volume cm ³	389	389	420
Power output controller	AVR	AVR	AVR
Engine start	manual/electro/auto		manual/electro
Power factor, cosφ	1	0,8	1
Dimensions (L*W*H), mm	700x545x590	700x545x590	700x545x590
Weight, kg	76,8	82,3	83
ATS	built-in	built-in	absent
Protection class	IP23M	IP23M	IP23M
Altitude (MAX), m	1000	1000	1000
Relative humidity	<95%	<95%	<95%
*Acceptable deviation of a current is 5%			

To ensure the reliability of the generator and increase its lifespan, the peak capacities may be slightly limited by circuit breakers.

The optimum operating conditions are ambient temperature of 17 – 25 °C, barometric pressure of 0.1 MPa (760 mm Hg), and relative humidity of 50 – 60%. Under such ambient conditions, the generator can guarantee maximum performance in terms of the stated specifications. In case of deviations from the above ambient values, the performance of the generator can be different.

Please note that in order to preserve the lifespan of the generator, continuous loads should not exceed 80% of the rated power.

MODELS DESCRIPTION

Model	KS 10000E	KS 10000E G	KS 10000E-3	KS 10000E ATS	KS 10000E-3 ATS
Voltage, V	230	230	400	230	400
Max Power, kW	8,0	8,0	8,0	8,0	8,0
Nominal Power, kW	7,5	7,5	7,5	7,5	7,5
Frequency, Hz	50	50	50	50	50
Current max, A	34,78	34,78	14,45	34,78	14,45
Outlets	1*16A 1*32A	1*16A 1*32A	1*16A 1*16A (3p)	1*16A 1*32A	1*16A 1*16A (3p)
Fuel Tank Volume, l	25	25	25	25	25
50% power working time	14	14	14	14	14
LED display	voltage frequency working hours	voltage frequency working hours	voltage frequency working hours	voltage frequency working hours	voltage frequency working hours
Noise level L _{PA} (7m)/L _{WA} , dB	71/96	71/96	71/96	71/96	71/96
Power output V/A	12/8,3	12/8,3	12/8,3	12/8,3	12/8,3
Engine model	KS 440	KS 440	KS 440	KS 440	KS 440
Engine type	gasoline 4 stroke cycle engine	LPG/gasoline 4 stroke cycle engine	gasoline 4 stroke cycle engine	gasoline 4 stroke cycle engine	gasoline 4 stroke cycle engine
Engine power, hp	18,0	18,0	18,0	18,0	18,0
Crank case volume, cm ³	1,2	1,2	1,2	1,2	1,2
Engine cylinder volume cm ³	440	440	440	440	440
Power output controller	AVR	AVR	AVR	AVR	AVR
Engine start	manual/ electro	manual/ electro	manual/ electro	manual/ electro/auto	manual/ electro/auto
Power factor, cosφ	1	1	0,8	1	0,8
Dimensions (L*W*H), mm	700x545x590	700x545x590	700x545x590	700x545x590	700x545x590
Weight, kg	85,5	85,5	88	87,8	89,2
ATS	absent	absent	absent	built-in	built-in
Protection class	IP23M	IP23M	IP23M	IP23M	IP23M
Altitude (MAX), m	1000	1000	1000	1000	1000
Relative humidity	<95%	<95%	<95%	<95%	<95%
*Acceptable deviation of a current is 5%					

To ensure the reliability of the generator and increase its lifespan, the peak capacities may be slightly limited by circuit breakers.

The optimum operating conditions are ambient temperature of 17 – 25 °C, barometric pressure of 0.1 MPa (760 mm Hg), and relative humidity of 50 – 60%. Under such ambient conditions, the generator can guarantee maximum performance in terms of the stated specifications. In case of deviations from the above ambient values, the performance of the generator can be different.

Please note that in order to preserve the lifespan of the generator, continuous loads should not exceed 80% of the rated power.

MODELS DESCRIPTION

Model	KS 7000E 1/3		KS 10000E 1/3	
Voltage, V	230	400	230	400
Max Power, kW	5,5	5,5	8,0	8,0
Nominal Power, kW	5,0	5,0	7,5	7,5
Frequency, Hz	50		50	
Current max, A	23,91	9,93	34,78	14,45
Outlets	1*16A/400V, 1*32A/230V		1*16A/400V, 1*32A/230V	
Fuel Tank Volume, l	25		25	
50% power working time	17		15	
LED display	voltage, frequency, working hours		voltage, frequency, working hours	
Noise level L _{PA} (7m)/L _{WA} , dB	70/95		71/96	
Power output V/A	12/8,3		12/8,3	
Engine model	KS 390		KS 440	
Engine type	gasoline 4 stroke cycle engine		gasoline 4 stroke cycle engine	
Engine power, hp	13		18	
Crank case volume, cm ³	1,1		1,2	
Engine cylinder volume cm ³	389		440	
Power output controller	AVR		AVR	
Engine start	manual/electro		manual/electro	
Power factor, cosφ	1/0,8		1/0,8	
Dimensions (L*W*H), mm	700x545x590		700x545x590	
Weight, kg	81,8		95	
Protection class	IP23M		IP23M	
Altitude (MAX), m	1000		1000	
Relative humidity	<95%		<95%	
*Acceptable deviation of a current is 5%				

To ensure the reliability of the generator and increase its lifespan, the peak capacities may be slightly limited by circuit breakers.

The optimum operating conditions are ambient temperature of 17 – 25 °C, barometric pressure of 0.1 MPa (760 mm Hg), and relative humidity of 50 – 60%. Under such ambient conditions, the generator can guarantee maximum performance in terms of the stated specifications. In case of deviations from the above ambient values, the performance of the generator can be different.

Please note that in order to preserve the lifespan of the generator, continuous loads should not exceed 80% of the rated power.

9. CONTROL PANEL TYPES

9.1. GENERATOR PANEL

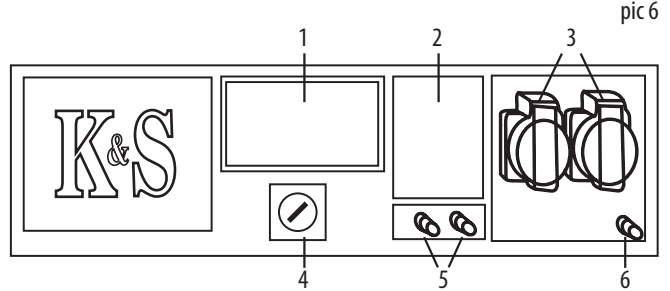

1. LED display
2. Emergency circuit breaker
3. Sockets
4. Start/electrostart
5. Direct current sockets 12 V
6. Grounding

9.2. GENERATOR PANEL FOR MODELS: KS 7000E ATS, KS 7000E-3 ATS, KS 10000E ATS, KS 10000E-3 ATS

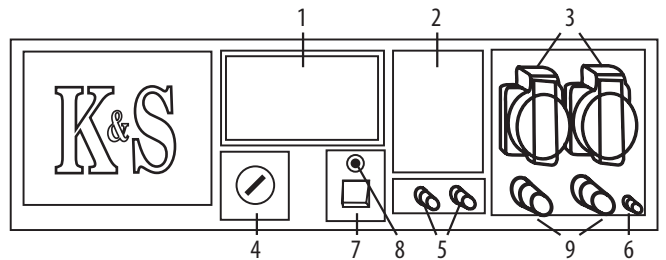

- | | |
|--------------------------------|-------------------|
| 1. LED display | 6. Grounding |
| 2. Emergency circuit breaker | 7. ATS switch |
| 3. Sockets | 8. ATS indicator |
| 4. Engine start key (ON/OFF) | 9. ATS connectors |
| 5. Direct current sockets 12 V | |

9.3. GENERATOR PANEL FOR MODELS: KS 7000E 1/3, KS 10000E 1/3

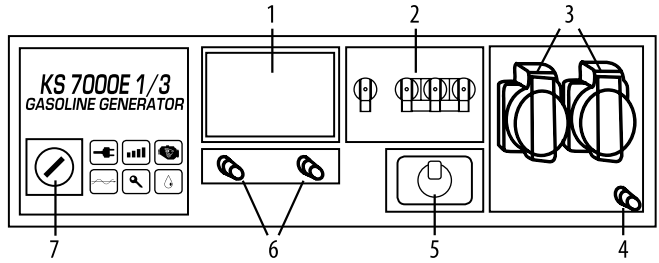

- 1. LED display
- 2. Emergency circuit breaker
- 3. Sockets
- 4. Grounding
- 5. 3 phase / 1 phase mode switch (position 1 - 400V, position 0 - off, position 2 - 230V)
- 6. Direct current sockets 12 V
- 7. Engine start key

FOR THREE-PHASE DIESEL GENERATOR

Three-phase diesel generator load must be distributed on all three phases, and the load on all phases must be balanced. The load on 1 phase should not exceed 1/3 of the total generator capacity. Maximum permissible imbalance is 20%. Only 1 or 2 phase load leads to the generator breakage. The total load and total current on all three phases should not exceed nominal load and current of the generator.

CONNECTING DEVICES

After starting the engine, make sure the voltmeter readings correspond to the nominal (at 50 Hz 230V $\pm 10\%$ for single-phase units and 400 $\pm 10\%$ for threephase).

10. DIGITAL DISPLAY OF GASOLINE GENERATORS

The choice of indicators occurs by pressing a button on the display, selection of indicators is cyclic.



In this mode, the display shows the voltage, in volts.



In this mode, the display shows the current frequency, in hertz.



This mode displays the generator's running time from the moment it starts, in minutes.



In this mode, the display shows the total number of hours worked by the generator.



The generator is off.

11. COMMISSIONING

The generator is supplied without fuel. Before the operation please fill the fuel. Guidelines for filling are below. Generators are supplied without motor oil. The generator casing may contain residues of oil after tests conducted during production.

Before starting to use the generator, be sure to pour oil. Recommendations on oil and it's filling process are below. Follow maintenance recommendations during the first month or twenty hours (whichever occurs first) contained in the «Maintenance» section. For commissioning models with elektrostart please charge the battery. Please use additional battery charger (not included) to charge the battery or let the generator work at least one hour at 50% load at the first start.

It is recommended to ground the generator before operating it for the first time.

GROUND TERMINAL

The ground terminal forms a ground line to prevent electric shock. If the electrical appliance is grounded, the generator must also be grounded.

IN THE FIRST 20 OPERATING HOURS OF THE GENERATOR, THE FOLLOWING REQUIREMENTS SHOULD BE MET:

1. During commissioning, do not connect power consumers, the power of which exceeds 50% of the nominal (operating) power of the device.
2. After the first 20 operating hours, be sure to change the oil. It is better to drain oil while the engine is still hot after operation to ensure quick and complete oil draining.
3. Check and clean the air filter, fuel filter and spark plug.



IMPORTANT!



Before starting the generator, connect the ground wire to the ground

12. BEFORE STARTING

12.1. CHECK THE FUEL LEVEL

1. Please wear protective gloves to avoid getting gasoline on the skin.
2. Remove the fuel tank cap and check the fuel level
3. Add fuel to the filter level if necessary
4. Screw the fuel tank cap back tightly

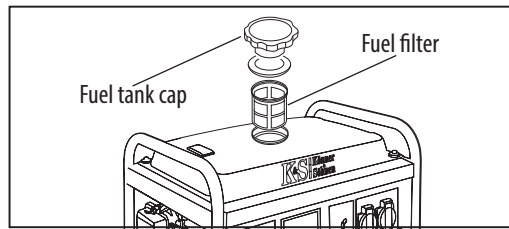

pic 8



IMPORTANT!



**Only unleaded gasoline is recommended for the generator.
The use of other fuels could cause engine damage.**

12.2. CHECK THE OIL LEVEL

1. Please wear protective gloves to avoid getting oil on the skin.
2. Unscrew the oil level gage and clean it with clean cloth.
3. Put the oil gage back without screwing it.
4. Take the oil level gage out and check the oil level according to the mark on a gage.
5. Add oil if it's level is below the mark on a gage.
6. Screw the oil gage back.

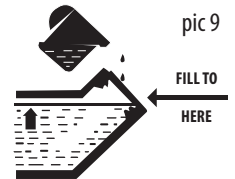

pic 9



IMPORTANT!



If the generator has not been used for a long time, try charging the battery with the battery charger (not included).

13. CONNECTION OF GENERATOR WITH BUILT-IN ATS

Connection of the generator with the built-in ATS to the consumers of electricity and the central power supply.

13.1. SCHEME OF CONNECTION OF A SINGLE-PHASE GENERATOR

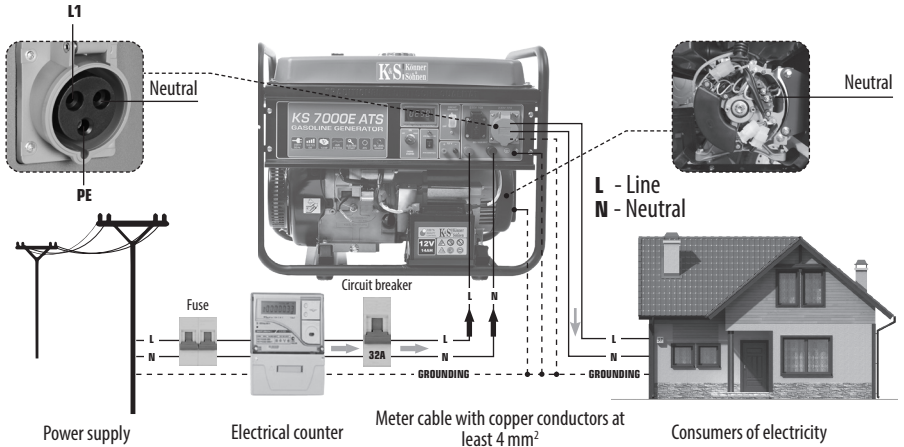

13.2. CONNECTION SCHEME OF THE THREE-PHASE GENERATOR

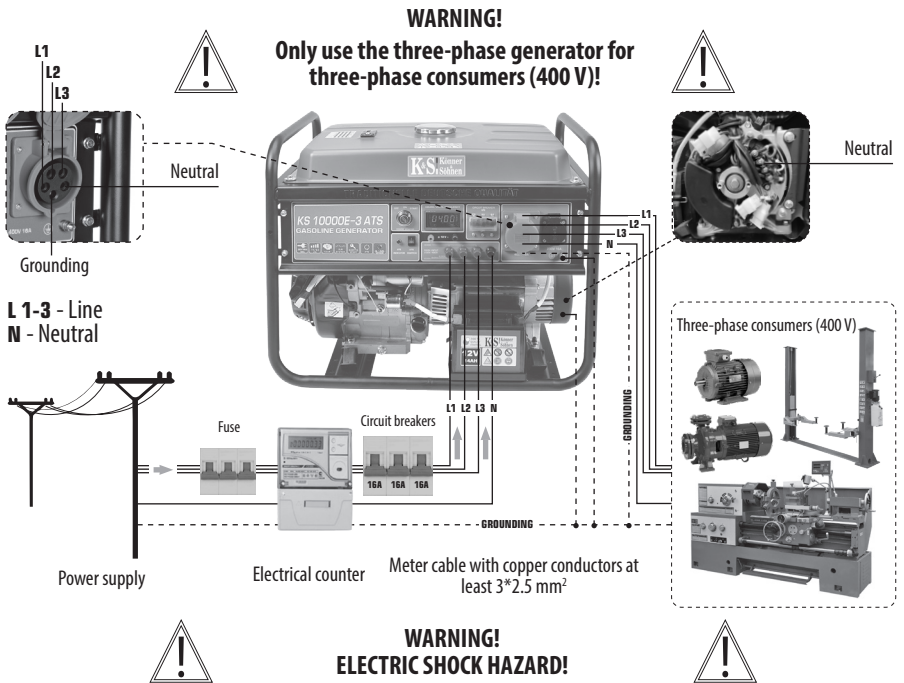

WARNING! The N-conductor (neutral conductor) of the generator is not connected to the housing and the PE conductor of the generator. For TN network, the N-conductor (under the alternator cover) must be connected to the main earthing bar of the building.

*In practice, there are different options for supplying electricity, and different rules for connecting it. Therefore, the diagrams for equipment installation given in the operating manual are for informational purposes only and are not instructions for installation. The decision on how to properly connect the equipment in each individual case must be made by a certified electrician who performs the installation. The manufacturer is not responsible for incorrect installation, and is not responsible for any material and physical damage that may result from improper installation or operation of the equipment.

14. ENGINE START



Before starting the engine please make sure that power of instruments or electric consumers complies to the capacities of the generator. It is forbidden to exceed its nominal capacity. Do not connect devices before starting the engine. In power supply mode within range from nominal till maximum power, the generator may operate not more than 30 minutes.

Before turning the generator on, verify that the connected devices are in working order. If the connected device suddenly stops running – turn the power off by means of an emergency switch, disconnect the device and check it.



Warning! Do not let the simultaneous connection of two or more devices. Start of many devices requires large power capacity. Devices are to be connected in turns, according to its maximum allowed power. Do not connect the consumers in first 1-2 minutes after the generator start.

14.1. GASOLINE GENERATOR ENGINE START

1. Fuel supply valve to be set in "OPEN" position.
2. Air shutter to be set to "CLOSED" position.
3. Upon manual start – set the engine switch to "ON" position.
4. Start slowly pulling the starter till you feel slight resistance. By an abrupt movement pull the starter to full cord length. The engine will now start.
5. Upon electric start – turn the key to ON position and hold it in START position till the engine starts. Immediately release the key after the engine starts.
6. Slowly turn the air shutter to "OPEN" position.

Fuel valve

pic 10

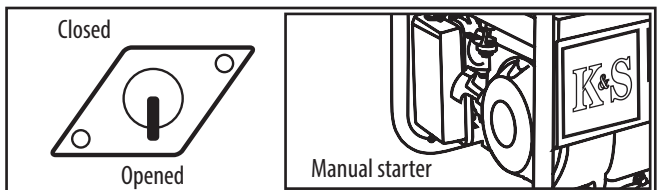

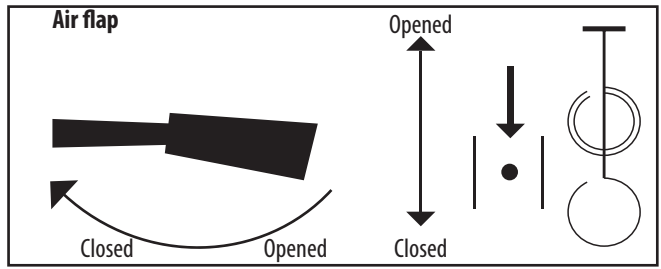

IMPORTANT!



Please note, several unsuccessful attempts to start the generator using elektrostart, may mean that the battery is discharged. Therefore please perform a full battery charge before operation.

14.2. RUNNING GENERATOR ON LIQUEFIED GAS

1. Connect the hose to the gas cylinder.
2. Open the gas supply valve on the tank, make sure there are no gas leaks.
3. Set the fuel valve on fuel tank to the closed position (there should be no fuel in the carburetor).
4. Set the air flaps in the middle position. After starting the generator, put it in the open position.
5. When you use generator for the first time to let LPG go into the gas supply system turn the key to the OFF position and pull the starter handle all the way down the cord 2-3 times.
6. For elektrostart generators - turn the key in the "START" position and hold in that position for several seconds before starting the engine.
7. To manually start the generator turn the key to position "ON", grasp the starter handle and slowly pull it for feeling resistance. Abruptly pull the starter cord at full length.
8. Turn the air damper to "OPEN".

pic 12

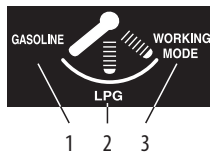

1. Position the air flaps when running on gasoline.
2. Position the air flaps when running on gas.
3. Working mode.

**IMPORTANT!**

Place the container with gas only vertically, according to the instruction manual for gas cylinders. The horizontal placement of gas cylinders leads to hybrid generator gearbox failure.

**IMPORTANT!**

Disconnect the load from the generator before changing the fuel type!

Fuel can be changed without stopping the generator. When the generator is running on gasoline, simply set the fuel switch to "OFF", connect the gas hose to the generator and open the gas valve. When switching from gasoline to LPG operation, there is still some gasoline left in the carburetor, which means that the generator will be unstable for the first 5 minutes. The generator becomes stable once all gasoline is removed from the fuel system and the generator fully switches to LPG operation.

14.3. GENERATOR LAUNCH IN ATS MODE (FOR GENERATORS WITH ATS):

Built-in automatic start system allows controlling the generator switching on and off in automatic mode. If the main power shuts down, the system will notice that and will start compensation procedures.

To start the generator engine in ATS mode:

1. Check if the accumulator unit is charged. Oil level is to be sufficient. Also confirm the fuel tank filling.
2. Connect the power from main power supply to a corresponding inlet at the generator panel.
3. Set the ATS switch to AUTO position.
4. Set the starting key to "ON" position at the generator panel.

**IMPORTANT!**

Upon activated ATS system when the electric power from main electric network passes through the generator to the connected devices, its accumulator unit is charging. Do not disconnect the battery.

If the power supply from the main network will be stopped, the ATS system will automatically start the generator so that it begins to supply power to devices connected to it. When the power supply from the main network is renewed, the generator system turns off and the voltage to consumers goes from the main network.

In order to run the generator without ATS mode – do not set the ATS switch to AUTO mode.

DURING GENERATOR OPERATION:

- You may use the generator, if the voltage meter displays the value 230V + / - 10% (50Ng).
- Watch the voltage meter and in case of excessive indices values, stop the generator operation.
- Connection to continuous voltage socket is used for accumulator recharge only. Upon accumulator unit recharge, it is mandatory to verify the polarity correctness (+ to +, - to -).
- Wires of charging device are to be at first connected to the accumulator unit and only then – to the generator itself. All “generator to network” connections are to be carried out by a certified electrician. Any mistakes may result in serious equipment damage.
- It is forbidden to use 12V voltage simultaneously with 230V.

15. STOPPING THE ENGINE

**IMPORTANT!**

Do not stop the generator, if there are any devices connected. This may result in generator breakdown.

15.1. TO STOP GASOLINE GENERATOR ENGINE:

1. Stop all power consuming devices connected to the generator, by setting the emergency switch to OFF.
2. Please let the generator to work for 3 minutes without load to cool the alternator.
3. In case of manual start – set the engine switch to OFF position.
4. In case of electric start, turn the key to OFF position.
5. Turn the fuel valve to CLOSED position.

15.2. TO STOP HYBRID GENERATOR ENGINE:

1. Stop all power consuming devices connected to the generator, by setting the emergency switch to OFF.
2. Please let the generator to work for 3 minutes without load to cool the alternator.
3. In case of manual start – set the engine switch to OFF position.
4. In case of electric start, turn the key to OFF position.
5. Twist gas cylinder valve to CLOSED position.

16. TECHNICAL MAINTENANCE WORKS

Works, specified in “Technical maintenance” section, are to be regularly performed. If the end user has no means for performing regular maintenance independently, it is necessary to address the official service centre to place an order for such works performance.

**IMPORTANT!**

In case of any damages, occurred due to non-performance of regular maintenance works, the manufacturer bears no responsibility for such damages.

Such damages are also:

- Damages occurred as a result of using non original spare parts;
- Corrosion damages and other results of improper equipment storage;
- Damages occurs as a result of maintenance performance by inexperienced and unauthorized specialists.

This manual compliance.

Technical maintenance, operation and Könnert & Söhne™ generator storage are to be performed according to this manual recommendations. Manufacturer bears no responsibility for damages and losses, caused by non-compliance to safety requirements and technical maintenance rules.

First of all this applies to:

- use of lubricants, gasoline and motor oils, forbidden by the manufacturer;
- device technical alterations;
- equipment operations against its intended use;
- indirect damages, caused by operating faulty equipment;

17. MAINTENANCE SCHEDULE

Node	Service type	Before starting	First month or 20 hours	Every month or 20 operating hours	Each 3 months or after 50 working hrs	Each 6 months or after 100 working hrs	Each year or after 300 working hrs
Motor oil	Checking level	✓					
	Changing		✓		✓		
Air filter	Checking/ Clean out	✓	✓	✓			
	Changing						✓
Sparking plug	Checking/ Clean out					✓	
	Changing						✓
Fuel tank	Checking level	✓					
	Clean out						✓
Fuel line	Check (replace if needed)					✓	

18. RECOMMENDED OILS

Motor oil has a serious impact on performance characteristics and is a major attribute, defining its service life. Use oils designed for four-stroke cycle vehicle engines, since such oils contain cleaning additives, which comply or even exceed SE standards according to API classification (or equivalent).

In general, the engine is recommended to run with motor oils of SAE 10W-30, SAE 10W-40 viscosity level. Motor oils with other viscosity levels, may be used only if the average air temperature in your region does not exceed the limits of the temperature range, specified in the table. Oil viscosity according to SAE standards or service category, are specified on the API capacity sticker.

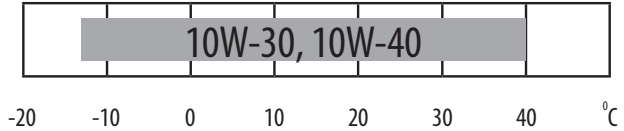

ENGINE OIL REPLACEMENT OR ADDING

Upon oil level decrease it is necessary to add the required quantity in order to provide the correct generator operation. It is necessary to check the oil levels according to technical maintenance schedule.

To replace engine oil, perform the following actions:

1. Wear protective gloves to avoid getting oil on the skin.
2. Place a drain oil holding tank under the engine.
3. Turn the drain cap, located in the engine under the oil-depth gage cap, by means of a hexagon spanner 10 mm for all verifications of KS 3000.
4. Wait till the oil drains.
5. Replace the drain cap and tighten it well.
6. Please drain the oil while the engine is warm. This provides a quick and complete oil drain.

To refill oil, perform the following actions:

1. Wear protective gloves to avoid getting oil on the skin.
2. Make sure that the generator is set on flat level surface.
3. Open the oil-depth gage cap on the engine
4. By means of a funnel, pour the advanced purification engine oil to the crankcase. The funnel is not included. Oil level after filling, has to be close to the upper part of oil filler.

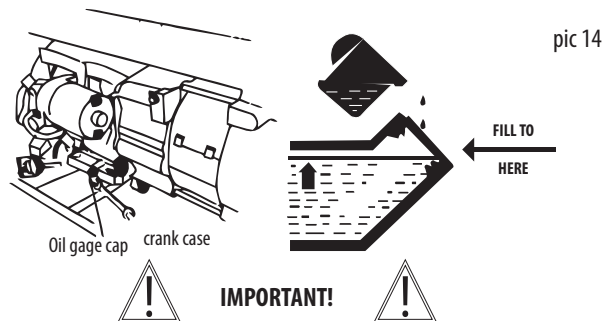

Oil pollutes land and groundwater. Do not allow the oil leaking from the crankcase. Drain used oil to a tightly closing container. Return used oil into recycling of wasted oil.

19. AIR FILTER TECHNICAL MAINTENANCE

It is necessary to, from time to time, check the air filter and clean any contaminations. Regular air filter maintenance is necessary to maintain sufficient carburetor air inflow.

Cleaning the filter:

1. Open the clips on the upper cap of the air filter.
2. Remove the sponge filtering element.
3. Remove all dirt deposits inside the hollow case of the air filter.
4. Thoroughly wash the filtering element in warm soapy water.
5. Dry the sponge filter.
6. Dry filtering element is to be moistened by machine oil and excess oil is to be squeezed out.



IMPORTANT!



Air filter replacement is to be performed each 50 hours of the generator operation (every 10 hours in unusually dusty conditions).

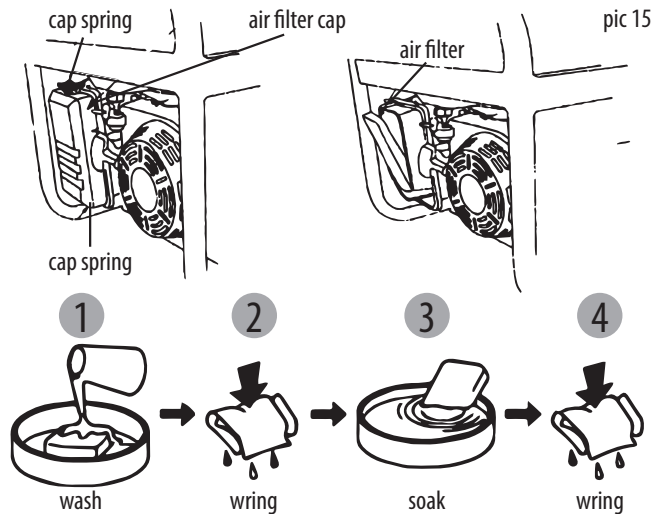

20. SPARK PLUGS TECHNICAL MAINTENANCE

Spark plug is an important element providing the correct engine operation. It has to be intact, without soot deposits and to have a correct gap.

Spark plug verification:

1. Remove the cap from the spark plug.
2. Remove the spark plug by means of a corresponding spanner.
3. Examine the spark plug. If it is shattered – it is necessary to replace it. Recommended replacement spark plugs – F7TC.
4. Measure the gap. It has to be within range 0.7 – 0.8 mm.
5. In case of repeated use, the spark plug has to be cleaned by means of a metal brush. After that – set the correct gap.
6. Place the spark plug in its place by means of a spark plug spanner.
7. Replace the spark plug cap.

pic 16

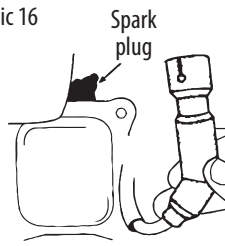

pic 17

0,70 - 0,80 mm



Electrode

21. BATTERY USE

The generator battery is not subject to service. If the generator is not used for a long time, the battery may fail. To prolong battery life it is recommended to do battery charging with an external device (not included) every three months.

Please use protective gloves when working with battery. The battery contains acid electrolyte, which is dangerous. After contact with skin or face, rinse immediately with plenty of water and seek for medical advice.

Battery warranted - three months from the date of purchase of the generator.

22. STORAGE

Storage room has to be dry and free from dust deposits. Storage room also has to be locked away from children and animals. It is recommended to store and use the generator at temperature of -20 to +40°C. Avoid direct sunlight, rain on the generator. When using and storing hybrid generator, gas tank should be kept indoors at temperatures below +10°C. If the temperature is lower, gas will evaporate.



IMPORTANT!



Warning! Generator is to remain ready for operation at all times. Therefore in case of device malfunctions, they are to be repaired before dismantling the generator for storage.



IMPORTANT!



Before long-term storage of the generator during the engine work close the fuel valve and let the engine to elaborate gasoline from carburetor. Wait until engine stops itself.

Before long-term generator idle time – perform the following actions:

- Generator and engine external parts (especially the cooling radiators) are to be thoroughly cleaned.
- Carburetor float chamber screw has to be removed and the chamber – drained.
- Remove the spark plug.
- Oil drain screw is to be removed and the oil – drained.
- Pour one teaspoon of motor oil to the cylinder (5-10 ml). After that – pull the starter cord for a few times, to let the oil equally distribute on the cylinder walls.
- Install the spark plug.
- Pull the starter handle until you feel the resistance. to let the piston relocate to the upper pressure tact point.
- Smoothly release the starter handle.
- Remove the battery terminals. Grease the battery terminals and connecting terminals with grease to protect against oxidation.

23. GENERATOR TRANSPORTATION

For easy generator transportation use packaging, which generator was sold in. Secure the box with the generator to avoid tipping it on the side of the carriage. Before moving the generator drain the fuel and disconnect the terminals of the battery.

To move the generator from one place to another lift it by holding the frame. Be careful - the generators are heavy (40 to 90 kg). At least two men are needed to move the generator. Be careful, do not expose your feet under the frame of the generator.

24. POSSIBLE FAILURES AND SOLUTIONS

Typical failures	Possible reason	Solution
Engine does not starting	Engine starting swinch set to OFF position	Set the engine starting switch to ON
	Fuel valve set to off position	Turn the valve to ON position
	Air flap is opened	Shut the air flap
	No fuel	Add fuel
	Low-quality or dirty fuel is in engine	Change the fuel
	sparking plug smoked or corrupted distance between contacts is not nominal	Clean or replace the plug; Set proper distance between contacts
Low engine power / heavy starting	Dirt in fuel tank	Clean the fuel tank
	Dirt in the air filter	Clean the air filter
	Water in a fuel tank/ carburetor; carburetor is jammed	Empty the fuel tank, carburetor
	Distance between contacts of a sparking plug is not nominal	Set proper distance between contacts
Engine overheated	Cooling fins are dirty	Clean the cooling fins
	Air filter is dirty	Clean the air filter
No voltage while working engine	Circuit breaker is active	Turn on the circuit breaker
	Connected cables are corrupted	Check the cables; if using extension cord, change it
	Plugged device failure	Try to connect other devices
Connected devices are not working while generator is running	Generator is overloaded	Unplug some devices to reduce load
	Short circuit occured in one of the devices connected	Unplug that device to restore the stability of a system
	Air filter is dirty	Clean the air filter
	Repetitions of an engine are lower than nominal	Contact the service center

25. AVERAGE POWER USAGE

Device	Average power usage, w
Air hair dryer	450-1200
Iron	500-1100
Electric cooking stove	800-1800
Toaster	600-1500
Coffee machine	800-1500
Air heater	1000-2000
BBQ Grill electric device	1200-2300
Vacuum cleaner	400-1000
Radio	50-250
TV set	100-400
Refrigerator	100-150
Oven	1000-2000
Freezer	100-400
Drill	400-800
Hammer drill	600-1400
Grinding machine	300-1100
Circular saw	750-1600
Electro planer	400-1000
Electro jigsaw	250-700
Angle grinder	650-2200
Compressor	750-3000
Water pump	750-3900
Electric sawing machine	1800-4000
High pressure machine	2000-4000
Electric lawn	750-3000
Air conditioner	1000-5000
Electric powered engines	550-5000
Electric fan	750-1700

26. WARRANTY SERVICE TERMS

TERMS AND CONDITIONS:

The international manufacturer warranty is 1 year. The warranty period starts from the date of purchase. In cases when warranty period is longer than 1 year according to local legislation please contact your local dealer. The Seller which sells the product is responsible for granting the warranty. Please contact the Seller for warranty. Within the warranty period, if the product fails because of defects in the production process, it will be exchanged on the same product or repaired.

The warranty card should be kept throughout the warranty period. In case of warranty card loss, a second one will not be provided. The customer must provide the warranty card and buyer's check during request for repair or exchange. Otherwise, the warranty service will not be provided. The warranty card, attached to the product during sale, should be correctly and fully completed by the retailer and customer, signed and stamped. In other cases, warranty is not considered as valid.

Provide clean product to the service center. Parts, that must be replaced, are the property of the service center.

WARRANTY DOES NOT COVER:

- If the user has failed to comply with the instructions in this manual.
- If the product features damaged or missing identification stickers or labels, serial numbers, etc.
- If product malfunction was due to improper transportation, storage and maintenance.
- In case of mechanical damages (cracks, chips, impact and fall marks, deformation of housing, power cord, plug or any other components), including those resulting from the freezing of water (ice formation), provided there are foreign objects inside the unit.
- If the product has been improperly installed and connected to the mains supply or misused.
- If the claimed malfunction cannot be diagnosed or demonstrated.
- If proper operation of the product can be restored following cleaning from dust and dirt, appropriate adjustment, maintenance, oil change, etc.
- If the product is used for business related purposes.
- If faults are detected, which have been caused by product overload. Signs of overload are molten or discolored parts as a result of high temperatures, damaged cylinder or piston surfaces, degraded piston rings or connecting rod bushes.
- The warranty does not cover the failure of the product automatic voltage regulator due to careless handling or mishandling.
- If faults are detected, which have been caused by instability of the user's power grid.
- If there are faults caused by contamination or fouling such as contamination of the fuel, oil or cooling system.
- If electrical cables or plugs show signs of mechanical or thermal damage.
- In the event of foreign liquids and objects, metal chips, etc. inside the product.
- If the malfunction is caused by the use of non-original spare parts and materials, oils, etc.
- If there are two or more faulty units that are not interconnected.
- If the damage was caused by natural factors such as dirt, dust, humidity, high or low temperature, natural disasters.
- In case of simultaneous failure of the rotor and stator.
- For wear parts and accessories (spark plugs, nozzles, pulleys, filter and safety elements, batteries, detachables, belts, rubber seals, clutch springs, axles, hand starters, grease, mountings, working surfaces, hoses, chains, and tires).
- To preventive maintenance (cleaning, greasing, washing), installation and adjustment.
- If the product was tampered with, independently repaired or modified.
- In case of malfunctions resulting from normal wear and tear as a result of long-term use (end of life).
- If product operation was not stopped and continued after detecting a malfunction.
- Batteries supplied with equipment are covered by a warranty of three months.
- When using low-grade or inappropriate fuel.

26. BATTERY AND GENERATOR DISPOSAL

To prevent environment damage generator and battery should be separated from ordinary waste. Please recycle them in the safest way, passing it to special place for disposal.



EC Declaration of Conformity

Nr. 092

The following products have been tested by us with the listed standards and found in compliance with the European Community Machinery Directive 2006/42/EC, Low Voltage Directive 2014/35/EC, Electromagnetic compatibility Directive (EMC) 2014/30/EC, Noise Directive 2000/14/EC.

Manufacturer: DIMAX INTERNATIONAL GmbH
 Address: Hauptstr. 134, 51143 Cologne, Germany
 Product: Gasoline generators "Könner & Söhnen"
 Type / Model: KS 2900, KS 2900G, KS 3000, KS 3000E, KS 3000G, KS 3900E G, KS 5000E G, KS 7000, KS 7000E, KS 7000E G, KS 7000E-3, KS 7000E ATS, KS 7000E-3 ATS, KS 7000E-1/3, KS 9000E G, KS 10000E, KS 10000E G, KS 10000E-3, KS 10000E ATS, KS 10000E-3 ATS, KS 10000E-1/3.

The statement is based on a single evaluation of above mentioned products. It does not imply an assessment of the whole production and does not permit the use of the test lab. logo. The manufacturer should ensure that all product in series production are in conformity with the product sample detailed in this report. The applicant should hold the whole technical report at disposal of the competent all the right.

Applied EC Directives: 2006/42/EC Machinery Directive
2014/35/EC Low Voltage Directive
2014/30/EC Electromagnetic compatibility Directive (EMC)
2000/14/EC Noise Directive
(EU) 2016/1628 Non-Road mobile machinery emissions

Applied Standards: EN 55012:2007/A1:2009, EN 61000-6-1:2007
EN ISO 8528-13:2016, EN 60204-1:2006+A1:2009
EN ISO 3744: 1995, ISO 8528-10:1998

Gasoline engine KS 210, KS 390, KS 440 correspond to European Emission Standard Euro V. This is confirmed by EU TYPE-APPROVAL CERTIFICATE granted by NSAI certification. Technical service responsible for carrying out the test - TÜV SÜD Auto service GmbH in München, Germany
Date of issue 15/06/2018

2000/14/EC_2005/88/EC Annex VI

For Models: KS 2900, KS 2900G, KS 3000, KS 3000E, KS 3000G, KS 3900E G

Noise: measured L_{WA} =91 dB (A), guaranteed L_{WA} = 93 dB (A)

For Models: KS 5000E G, KS 7000, KS 7000E, KS 7000E G, KS 7000E-3, KS 7000E ATS, KS 7000E-3 ATS, KS 7000E-1/3

Noise: measured L_{WA} =93 dB (A), guaranteed L_{WA} = 95 dB (A)

For Models: KS 9000E G, KS 10000E, KS 10000E G, KS 10000E-3, KS 10000E ATS, KS 10000E-3 ATS, KS 10000E-1/3

Noise: measured L_{WA} =94 dB (A), guaranteed L_{WA} = 96 dB (A)



17

Issued Date: 2021-05-15
Place of issue: Warsaw city
Technical expert: Homenco A.

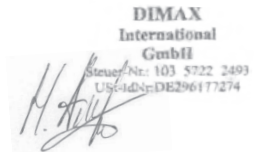

We DIMAX INTERNATIONAL GmbH hereby declare that specified above conforms covering European Parliament and Council Directives, 2006/42/EC of 17 May 2006 Machinery Directive, 2014/35/EC Low Voltage Directive of 26 February 2014, Electromagnetic compatibility Directive (EMC) 2014/30/EC of 26 February 2014, Noise Directive 2000/14/EC of 8 May 2000. The CE mark above can be used under the responsibility of manufacturer. After completion of an EC declaration of Conformity and compliance with all relevant EC directives.

CONTACTS

Deutschland:

DIMAX International GmbH
Flinger Broich 203 -FortunaPark-
40235 Düsseldorf, Deutschland
www.ks-power.de

Ihre Bestellungen

orders@dimaxgroup.de

Kundendienst, technische Fragen und Unterstützung

support@dimaxgroup.de

Garantie, Reparatur und Service

service@dimaxgroup.de

Sonstiges

info@dimaxgroup.de

Polska:

DIMAX International
Poland Sp.z o.o.
Polen, Warczawska, 306B
05-082 Stare Babice,
www.ks-power.pl
info.pl@dimaxgroup.de

Україна:

ТОВ «Техно Трейд КС»,
вул. Електротехнічна 47,
02222, м. Київ, Україна
www.ks-power.com.ua
sales@ks-power.com.ua

Россия:

ТД «Рус Энержи К&С» 129090,
г. Москва, проспект Мира,
д.19, стр.1, эт.1, пом.1,
комн.6б, офис 99В
www.ks-power.ru
info@ks-power.ru